

EXHIBIT NO. 1

27
5-10-05

Docket Item #
BAR CASE #2004-0274

City Council
May 10, 2005

ISSUE: Appeal of a decision of the Board of Architectural Review, Parker-Gray District approving a Certificate of Appropriateness for a new garage

APPELLANT: Raymond P. Deakins on behalf of petitioners

LOCATION: 325 North Patrick Street

ZONE: RB/Residential



PRINCESS ST.

N. PATRICK ST.

325

LOCATION OF GARAGE

I. EXECUTIVE SUMMARY

- A proposed garage at the rear of 325 North Patrick Street was approved by the Parker-Gray Board of Architectural Review and appealed by neighbors.
- The appeal was heard by the Council on April 16, 2005. By a 5-2 decision (Mr. Smedberg and Ms. Woodson opposed), Council asked that *the case be docketed for the next legislative meeting and that staff work with the applicant and consult with the appellant to identify ways to bring down the mass on the second floor.*
- The Council should consider:
 - Has the mass of the building been reduced enough to minimize neighborhood impact?
 - Is the building compatible with the 19th century neighborhood?
 - Should the utilitarian character of the alley be factored into the decision of what is an appropriate design at this location?
- Staff recommends that Council approve the revised design with the following conditions:
 - 1) That the garage be sided with fiber cement painted to match the house, rather than zinc panels;
 - 2) That the applicant record a zoning restriction form with the deed indicating the proposed office on the second floor of the garage will be used only as an office and not as a separate dwelling; and,
 - 3) That the statements below appear in the General Notes of the site plan so that on-site contractors are aware of the requirements:

Contact Alexandria Archaeology (703-838-4399) two weeks prior to any ground disturbing activity (such as coring, grading, filling, vegetation removal, undergrounding utilities, pile driving, landscaping and other excavations as defined in Section 2-151 of The Zoning Ordinance) on this property. City archaeologists will provide on-site inspections to record significant finds.

Call Alexandria Archaeology immediately (703-838-4399) if any buried structural remains (wall foundations, wells, privies, cisterns, etc.) or concentrations of artifacts are discovered during development. Work must cease in the area of the discovery until a City archaeologist comes to the site and records the finds.

The applicant should not allow any metal detection to be conducted on the property, unless authorized by Alexandria Archaeology.

II. BACKGROUND

The two story, two car garage with second floor home office was approved by the Board of Architectural Review (BAR) on January 26, 2005. The proposed garage is located at the rear of a lot which has a late 19th century, two story, frame house at the front. The proposed garage is sited on the public alley that runs north-south through the block. The appellant, who owns the property immediately to the north at 327 North Patrick Street, appealed the BAR approval on the grounds that the garage is incompatible with the surrounding neighborhood and with his property in terms of its appearance and mass. The appeal was signed by 30 neighbors.

On April 16, 2005, the appeal was heard with testimony from the appellant, Raymond Deakins, the applicants, William and Karen Conkey, the chair of the Parker-Gray Board of Architectural Review, William Cromley, Planning & Zoning staff and others. On a unanimous decision, Council asked that the case be docketed for the next legislative meeting and that staff work with the applicant and consult with the appellant to identify ways to bring down the mass on the second floor.

On April 20, 2005, staff met with William and Karen Conkey, the applicants and also the architects for the project, to discuss ways of reducing the mass on the second floor. On April 28, 2005, the Conkeys again met with staff and submitted the revised drawings. The applicants maintain that they have done all that is possible to reduce the mass of the building short of eliminating the second floor and that any further alterations would significantly impact the usefulness of the building. The applicants do not wish to eliminate the second floor or the office use. The revised plans are included as an attachment to this report. A model will be available for Council viewing at the hearing. On April 29, 2005, staff met with Mr. Deakins, the appellant, to discuss the revisions. Mr. Deakins was disappointed with the revisions. He had hoped for the elimination of the second story or a design more compatible with the 19th century character of the neighborhood.

Revisions to the plans

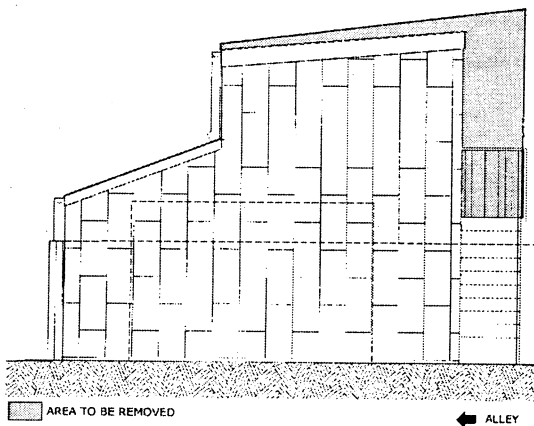

Figure 1 - Elevation facing appellant's property

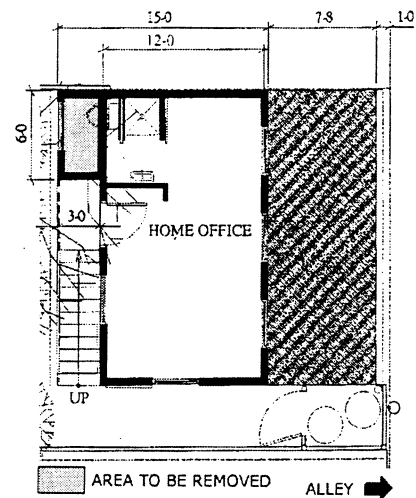

Figure 2 - Second floor plan view

The most significant alterations to the proposed garage are as follows:

- The overall height of the garage has been reduced by 1' at the west end; and,
- The "bump out" on the second story has been eliminated.

The ceiling height has been reduced on the second level. The west elevation, which faces in to the yard, was 17'8" in height. It is now 16'8" in height. The alley (east) elevation has been reduced by a lesser amount. It was 16' in height and is now 15'8" high. The prior design had a "bump out" on the west elevation which contained a portion of the bathroom and enclosed the second story landing for the exterior stair. This "bump out" cantilevered 3' from the west face on the north side; the side closest to Mr. Deakin's property. As a result, the second floor on the north elevation was 15' long. By eliminating the "bump out," the north elevation is now only 12' long. The elimination of the "bump out" also resulted in a number of minor alterations in the west elevation.

III. STAFF ANALYSIS

Staff believes that the mass and height of the garage have been reduced as far as they can without significantly impacting the applicants' objectives. Short of eliminating the second story, Staff does not believe there are additional alternatives. Any attempt to further reduce the height or footprint of the second story would result in an unuseable space. In the opinion of Staff, the mass and height of the building as currently proposed is appropriate for this location. However, Staff notes that if Council feels the mass or height is inappropriate, it may require further reduction or the elimination of the second story. As explained by the City Attorney at the April 16, 2005 hearing, the Board of Architectural Review, and by extension the City Council on appeal, may approve buildings at less than the envelope allowed by zoning regulations, if the Board or Council believes the smaller mass is appropriate.

Staff acknowledges that the design of the garage is unusual but believes that the *Design Guidelines* encourage a degree of design creativity within the larger framework of compatibility. The design of the garage is fairly routine except for the siding material and the west elevation. However, the west elevation faces in toward the rear of the house and will barely, if at all, be visible from the public right-of-way. On the other hand, Staff continues to believe that the building would be less visually prominent, and perhaps less objectionable to the appellant, if clad in a more traditional appearing material, such as fiber cement. The proposed zinc panels will be 15 3/4" wide by 32" long and will have an unfinished surface. Painted fiber cement looks similar to wood siding and can be applied as a horizontal lap siding or a vertical board-and-batten siding, both traditional 19th century exterior cladding types. Staff again requested that the applicants consider this change; they declined.

IV. STAFF RECOMMENDATION

Staff recommends that Council approve the revised design with the following conditions:

- 1) That the garage be sided with fiber cement painted to match the house, rather than zinc panels;
- 2) That the applicant record a zoning restriction form with the deed indicating the proposed

office on the second floor of the garage will be used only as an office and not as a separate dwelling; and,

3) That the statements below appear in the General Notes of the site plan so that on-site contractors are aware of the requirements:

Contact Alexandria Archaeology (703-838-4399) two weeks prior to any ground disturbing activity (such as coring, grading, filling, vegetation removal, undergrounding utilities, pile driving, landscaping and other excavations as defined in Section 2-151 of The Zoning Ordinance) on this property. City archaeologists will provide on-site inspections to record significant finds.

Call Alexandria Archaeology immediately (703-838-4399) if any buried structural remains (wall foundations, wells, privies, cisterns, etc.) or concentrations of artifacts are discovered during development. Work must cease in the area of the discovery until a City archaeologist comes to the site and records the finds.

The applicant should not allow any metal detection to be conducted on the property, unless authorized by Alexandria Archaeology.

ATTACHMENTS

Revised design for garage at 325 North Patrick Street

April 16, 2005 staff report for appeal

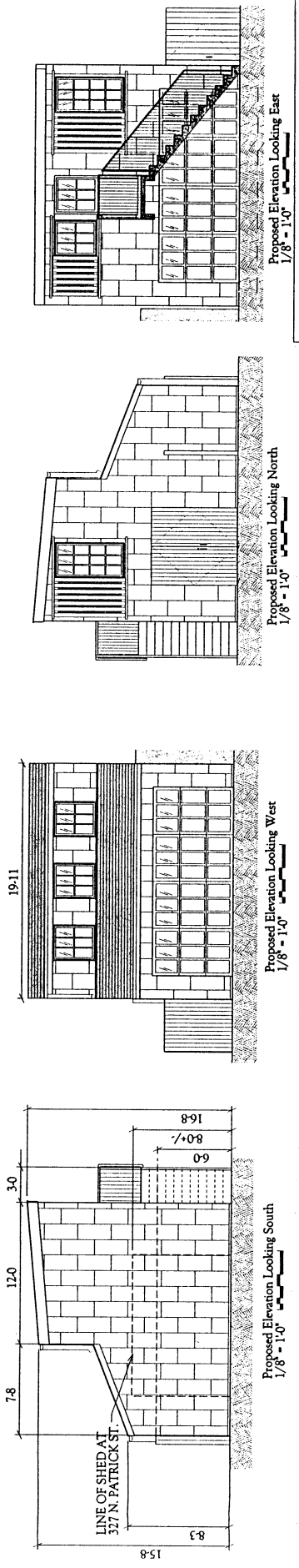
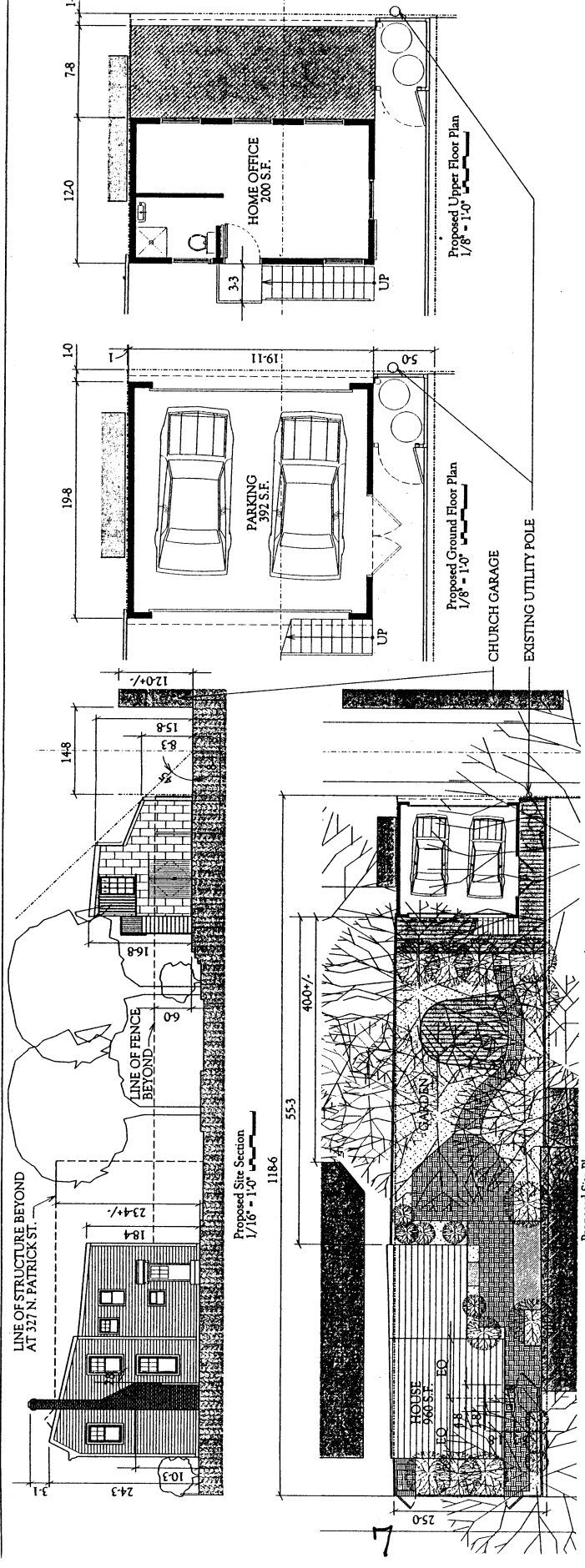

The Conkey Residence
 325 North Patrick Street Alexandria, VA 22314

The Parker-Gray Board of Architectural Review

Proposed Missing Alternate Design for Accessory New Garage Structure

SCALE AS NOTED

4-16-1005

A002

N

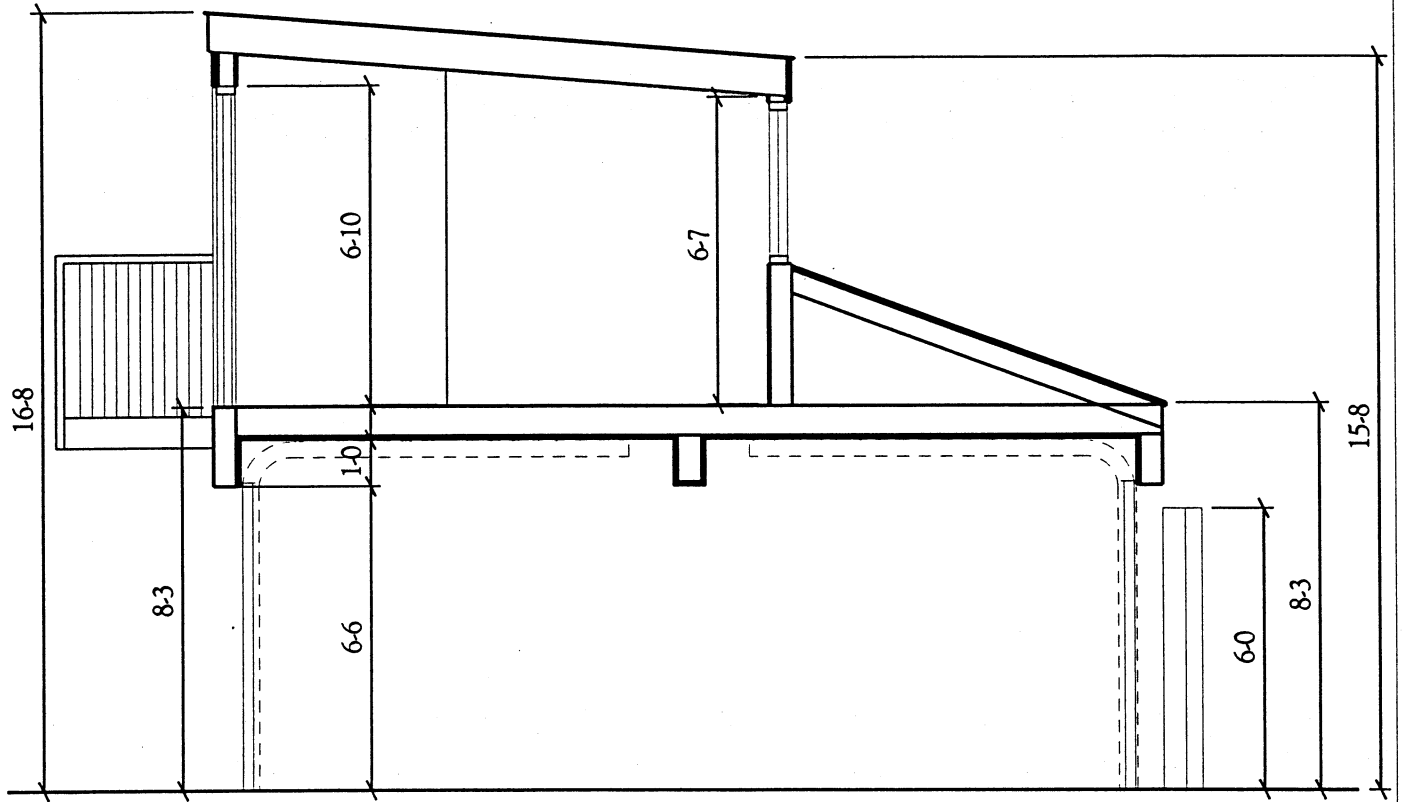

<p>The Conkey Residence 325 North Patrick Street Alexandria, VA 22314</p>		
<p>The Parker-Gray Board of Architectural Review</p>		
<p>Proposed Section</p>		<p>A009</p>
<p>SCALE 1/4" = 1'-0"</p>	<p>4-26-2005</p>	

12
4-16-05

Docket Item #
BAR CASE #2004-0274

City Council
April 16, 2005

ISSUE: Appeal of a decision of the Board of Architectural Review, Parker-Gray District approving a Certificate of Appropriateness for a new garage

APPELLANT: Raymond P. Deakins on behalf of petitioners

LOCATION: 325 North Patrick Street

ZONE: RB/Residential

Purpose

This appeal by the appellant asks whether the Board of Architectural Review should have approved the plans for a new garage at the rear of 325 North Patrick Street.

Background

On January 26, 2005, the Board of Architectural Review (BAR) heard an application for a garage and alterations at 325 North Patrick Street. The alteration, the addition of an exterior brick chimney on the south side of the existing house, was not appealed; only the new garage has been appealed. The Board approved the garage with the following conditions:

1. That the applicant record a zoning restriction form with the deed indicating the proposed office on the second floor of the garage will be used only as an office and not as a separate dwelling; and,
2. That the statements below must appear in the General Notes of the site plan so that on-site contractors are aware of the requirements:

Contact Alexandria Archaeology (703-838-4399) two weeks prior to any ground disturbing activity (such as coring, grading, filling, vegetation removal, undergrounding utilities, pile driving, landscaping and other excavations as defined in Section 2-151 of The Zoning Ordinance) on this property. City archaeologists will provide on-site inspections to record significant finds.

Call Alexandria Archaeology immediately (703-838-4399) if any buried structural remains (wall foundations, wells, privies, cisterns, etc.) or concentrations of artifacts are discovered during development. Work must cease in the area of the discovery until a City archaeologist comes to the site and records the finds.

The applicant should not allow any metal detection to be conducted on the property, unless authorized by Alexandria Archaeology.

The Board's vote on the motion was 4-2.

Historic map research indicates that there has not been any previous structure located at the rear of 325 North Patrick Street, where the proposed garage is to be located. The alley behind the property has had numerous structures fronting on it over the years, including several small dwellings, now replaced with garages. The two story, three bay, frame house with half mansard roof at the front of 325 North Patrick Street is a good example of highly popular Alexandria house type constructed for several decades beginning in the late 19th Century and continuing through the early 20th Century. The house at 325 North Patrick Street may date to as early as the 1870s.



Figure 1 - View north on Patrick Street with subject property on right

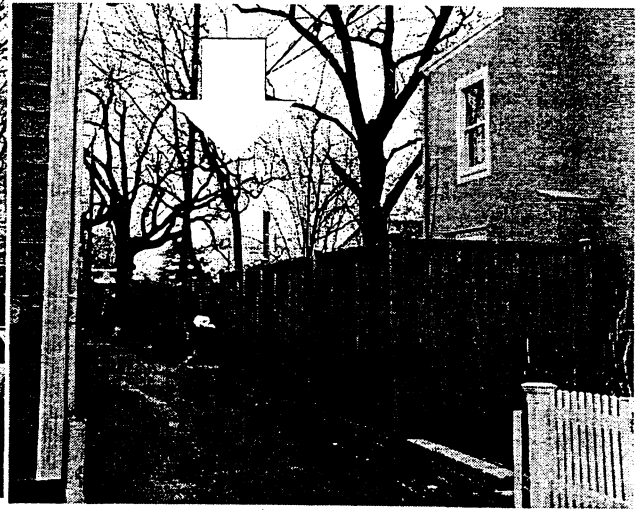

Figure 2 - View of alley from Princess Street



Figure 3 - View of rear of subject property



Figure 4 - View of interior of alley

Description of the proposed garage

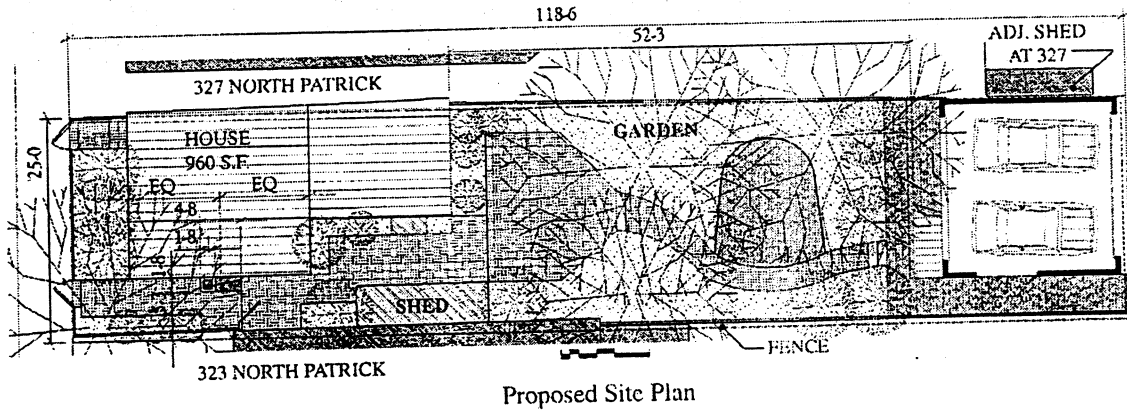

Figure 5 - Site Plan

Located at the rear of the property and oriented to the north-south alley, the two story frame garage will be composed of a nearly square (19'11" wide by 19'8" long) lower level for car parking and a smaller, rectangular (19'11" wide by 15' long) second level for home office use.

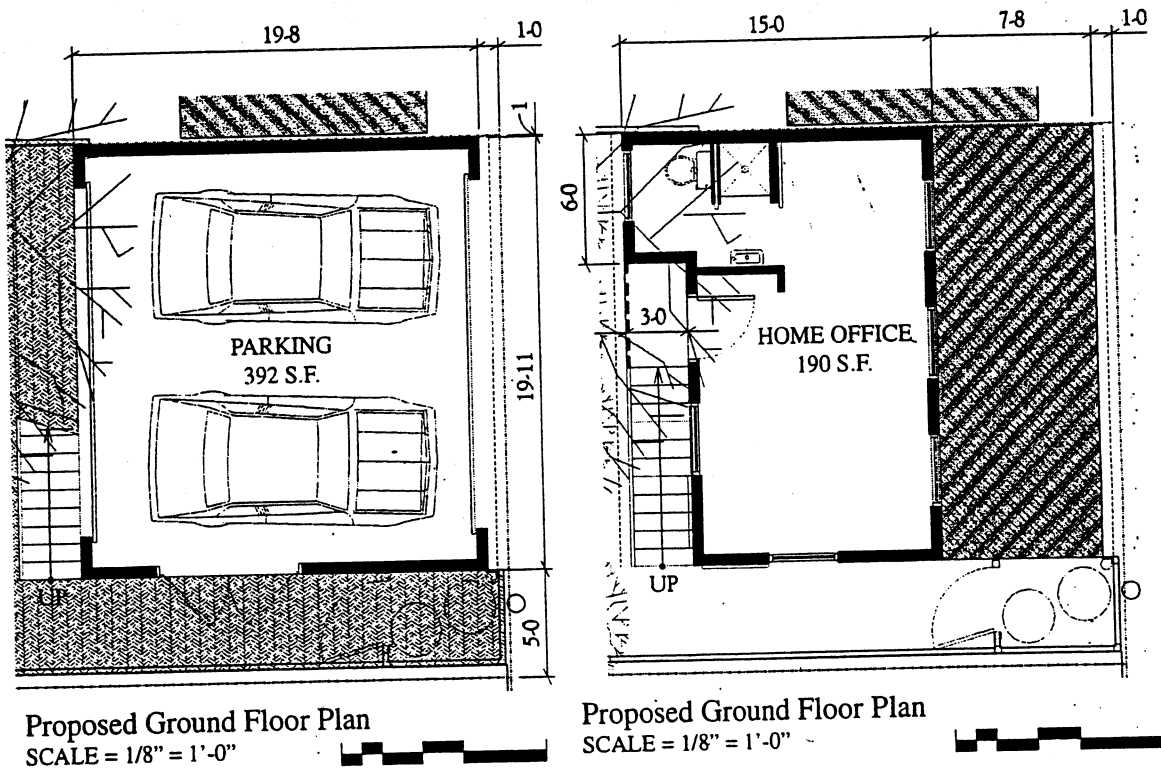

Figure 6 - Floor plan

The second level will be set back on the east (alley) elevation by 7'8" and will project on the west (yard) elevation by 3'. The offset second story creates a small pent roof above the first level on the alley elevation. Both this roof and the larger roof over the second story will slope down from the house side to the alley side, but the lower roof will have a steeper pitch than the upper roof. At its highest point, the garage will be 17'8" high.

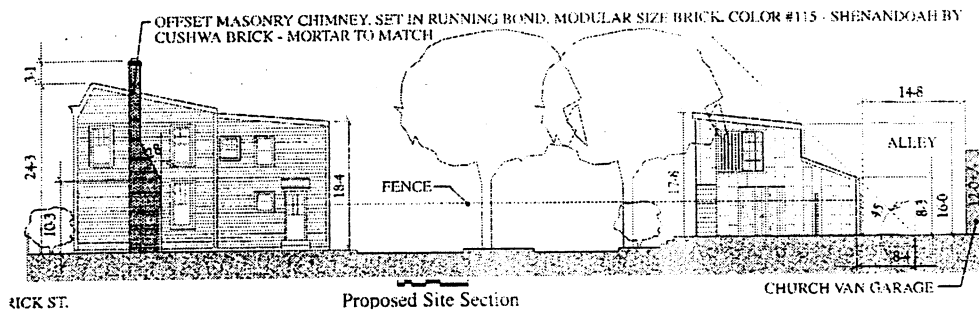
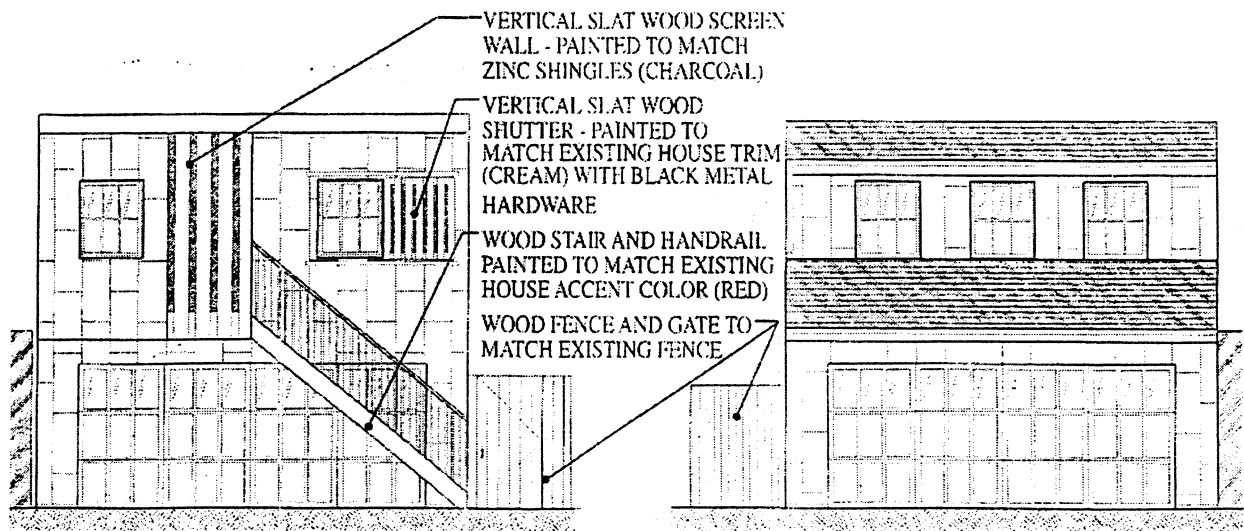

Figure 7 - Section through the site

On the east (alley) elevation, there will be a 16' wide garage door in the lower level. It will have multiple panels and a row of glazed lights at the top. There will be a series of three evenly spaced multi-light casement windows in the second level. The west (yard) elevation will have on the lower level a 16' wide garage door matching that on the alley side. As stated previously, the second level will project beyond the first on the yard side. The left hand side will be composed of a small cubicle-like extension with a multi-light casement window. To the right of this section will be an enclosed landing with a vertical slat wall and an open wood stairway from the landing to the yard. The stairway will have simple wood handrail with straight pickets. The north side elevation is on the property line and will have no openings. The south elevation is 5' from the property line and will have a pair of vertical slat wood doors in the first level and multi-light casement window with a vertical slat shutter in the second level.



Proposed Elevation Looking East

Proposed Elevation Looking West

Figure 8 - Front and rear elevation

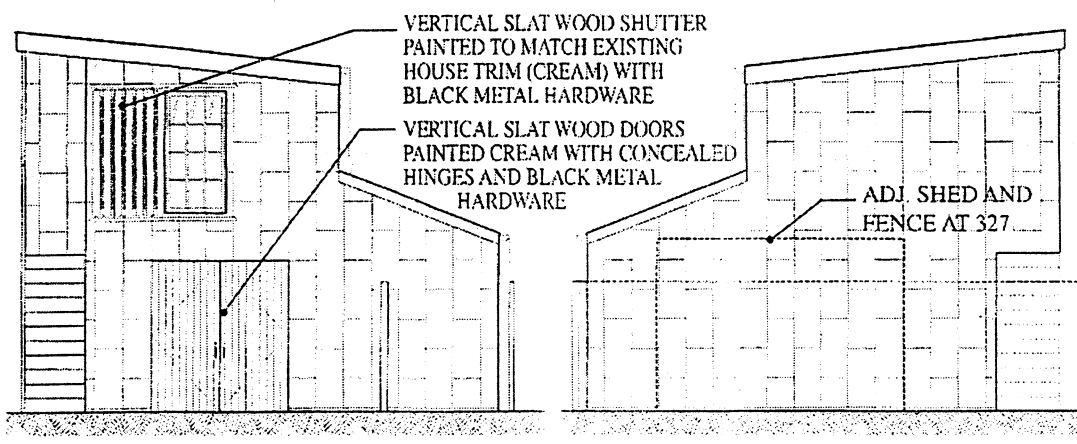

Proposed Elevation Looking North
Figure 9 - Side elevations

Proposed Elevation Looking South

The garage will be clad in a zinc wall system by VM Dexter consisting of 15 3/4" wide by 32" long panels made of zinc with a matte charcoal gray finish. The panels will be installed vertically with staggered seams. The roof will be clad in charcoal gray asphalt shingles. The downspouts and gutters will be zinc. The garage doors will be cedar finish. The windows will be wood simulated divided light windows painted cream to match the trim on the house. Other wood elements will be painted cream or red, matching the trim and accent color of the house or charcoal to match the zinc siding.

VM DEXTER ZINC WALL SYSTEM



Figure 10 - Zinc wall system

The proposed garage will be minimally visible from Patrick Street. It will be readily visible from the public alley at the rear and partially visible from Princess Street looking down the alley, known as Dulaney Court.

The proposed garage meets the zoning ordinance requirements.

Discussion

The Board approved the application for the new garage because they believed the garage met the *Design Guidelines*, which allow for "new and untried approaches," as long as they are compatible with the architecture in the district (*Design Guidelines*, New Residential Construction - Page 2). The Board felt that the design of the garage was appropriate given the simple, vernacular character of the Parker-Gray District and the location of the garage on an alley with a number of large, utilitarian structures. The two Board members in opposition were concerned about the compatibility of the design, the height of the structure and the advisability of the use of the zinc panels.

The appellant, who is the owner of the property next door at 327 North Patrick Street, opposes the design of the proposed garage. He believes it is incompatible with the neighborhood in terms of its style, materials and size. He believes that the appearance of the garage is incompatible with the 19th century buildings on the blockface and surrounding neighborhood. In addition, he objects to the potential impact on the light, air and privacy at the rear of his property at 327 North Patrick Street. These last issues do not strictly fall under the purview of the Board of Architectural Review. The appellant was joined in his appeal by 30 petitioners.

The Zoning Ordinance provides standards that are to be used to determine if approval of a Certificate of Appropriateness is warranted. The standards outlined in Section 10-205(A)(2)(b) of the Zoning Ordinance for new buildings and additions are addressed below:

1. **Height of the roofline along the street or public way** - The proposed structure is 17'8" high at the highest point, which is 23'8" in from the rear property line. Adjacent to the rear property line and alley, the garage is 8'3" high. The highest portion of the garage faces in toward the back of the house. The height of the garage at its highest point is 8" less than that of the lowest point of the house at 325 North Patrick Street at its back. The house is 24'3" at the front.
2. **Scale and mass of the building on the site** - The proposed structure is lower and smaller than the house at 325 North Patrick Street and the two adjacent houses at 323 and 327 North Patrick Street. The proposed alley facing structure is removed from the houses and will not easily be seen in relation to them. The proposed structure will have a smaller footprint than two nearby garage structures at 1 Dulaney Court and the rear of 908 Princess Street, which face the same alley as the proposed garage.
3. **Placement of the building on the site** - The proposed structure is placed at the rear of the property facing the alley, the traditional and logical location for a garage. The highest point of the garage faces into the lot, with the lower portion facing the alley. The applicant has made the point that the form of the garage, consisting of two sloped roofed blocks, one larger than the other is similar to that of structures throughout the district, including the house at 325 North Patrick Street. While the form of the garage mimics a traditional form found throughout the districts, it reserves the traditional order by placing the larger block behind the smaller, in relation to the street or, in this case, the alley.

4. **Material, texture and color** - Due to concerns about the accessibility of the alley for fire trucks, Code Enforcement has required that the garage be clad in a non-combustible material. A wall system by VM Dexter consisting of 15 3/4" wide by 32" long panels made of zinc with a matte charcoal gray finish is proposed. There is no known use of this wall system in the historic districts. It has a distinctly industrial appearance. The applicant has made the point that the proposed metal cladding of the garage is similar to the flat and corrugated metal panels frequently used to clad frame sheds and garages in the historic districts in the early- to mid-20th century.

With respect to materials, the *Design Guidelines* recommend the following:

The materials of accessory structures should follow the historic usage of materials. For example, accessory structures were often constructed of simpler materials than the main building. The materials of accessory structures should not detract from the materials of the main building (Accessory Structures - Page 3).

Staff objected to the use of the zinc panels as incompatible with the predominantly 19th century character of the house at 325 North Patrick Street and neighboring houses and recommended the use of Hardi plank, a manufactured building material composed of wood fibers and cement. Fiber cement is non-combustible and when painted has much the same appearance as painted wood. Unlike Staff, the Board felt the use of the metal panels was appropriate, given the use of similar materials in outbuildings historically and the vernacular and utilitarian character of neighboring garages in the alley.

The gray color of the zinc panels and cream and red trim are compatible with the house at 325 North Patrick Street and adjacent structures.

5. **Architectural style where there is a predominant style on the block face** - The style of the garage is distinctly different from the predominant styles on the block face, which are vernacular forms of the Italianate and federal styles. The detailing and materials of the garage give it a distinctly modern, utilitarian appearance. However, the elevation where the modern character is most overtly expressed is the west elevation which faces in toward the rear yard of 325 North Patrick Street and which is not expected to be readily visible from any public right of way. Regarding style, the *Design Guidelines* provide the following guidance:

Free standing accessory structures should complement, not compete with, the architecture of the main building (Accessory Structures - Page 2).

And,

New and untried approaches to common design problems are encouraged and should not be rejected out of hand simply because they appear to be outside the common practices outlined in the guidelines....[T]he Boards seek to promote compatible development that is, at once, both responsive to the needs and tastes of the [early 21st] century while being compatible with the historic character of the districts. This balancing act will clearly be different in different sections of the historic districts (New Residential Construction - Page 3).

The Board felt that the guidelines allow leeway in terms of style and that it was not inappropriate that the architectural character of the garage was more closely related more to alley than to the streetfront of the block.

6. **Architectural details, including signs, subject to public view from the public street or public way** - The architectural detailing of the garage combines traditional features such as multi-pane wood windows, wood trim and wood paneled garage door with details that have a distinctly modern flavor, such as the large metal panels and vertical slat shutters and screen.

To conclude, the Board approved the plans for the new garage, believing that the garage was architecturally compatible with its surroundings and that it complied with the *Design Guidelines*.

BAR Staff Position Before the Board:

BAR Staff recommended approval of the garage with the following conditions:

1. That the applicant record a zoning restriction form with the deed indicating the proposed office on the second floor of the garage will be used only as an office and not as a separate dwelling;
2. That the garage be clad in vertical board-and-batten fiber cement siding;
3. That the fiber cement be smooth finish and painted;
4. That the statements below must appear in the General Notes of the site plan so that on-site contractors are aware of the requirements:

Contact Alexandria Archaeology (703-838-4399) two weeks prior to any ground disturbing activity (such as coring, grading, filling, vegetation removal, undergrounding utilities, pile driving, landscaping and other excavations as defined in Section 2-151 of The Zoning Ordinance) on this property. City archaeologists will provide on-site inspections to record significant finds.

Call Alexandria Archaeology immediately (703-838-4399) if any buried structural remains (wall foundations, wells, privies, cisterns, etc.) or concentrations of artifacts are discovered during development. Work must cease in the area of the discovery until a City archaeologist comes to the site and records the finds.

The applicant should not allow any metal detection to be conducted on the property, unless authorized by Alexandria Archaeology.

(See BAR Staff report, Attachment 1)

Appeal

The Zoning Ordinance permits an appeal of the decision by the Board of Architectural Review to the City Council by the applicant or by 25 or more owners of real estate within the affected district who oppose the decision of the Board of Architectural Review. Raymond P. Deakins, owner of 327 North Patrick Street filed an appeal on February 9, 2005. The appeal included the signatures of 30 property owners within the Parker-Gray Historic District.

City Council Action Alternatives:

Council may uphold or overturn the decision of the Board of Architectural Review, using the criteria for approval of a Certificate of Appropriateness in §10-205(A)(2) Zoning Ordinance (Attachment 2). City Council may also remand the project to the Board with instructions to consider alternatives.

Attachments:

Attachment 1: B.A.R. Staff Report, January 26, 2005
Attachment 2: §10-205(A)(1-2): Criteria to be considered for a Certificate of Appropriateness

STAFF: Eileen Fogarty, Director, Department of Planning and Zoning; Hal Phipps, Division Chief, Zoning and Land Use Services; Elizabeth Hannold, Staff, Boards of Architectural Review.

REPORT ATTACHMENTS

Docket Item #5
BAR CASE #2004-0274

BAR Meeting
January 26, 2005

ISSUE: Garage and alterations
APPLICANT: Karen and Bill Conkey
LOCATION: 325 North Patrick Street
ZONE: RB/Residential

BOARD ACTION, January 26, 2005: Tie vote, 3-3 (Exterior Chimney).

The Board split the case into two separate motions. On a motion by Mr. Lloyd, seconded by Mr. Zuckerkandel, the Board voted 3-3 (Ms. Kelley, Mr. Meick and Mr. Luby were opposed) to approve the new exterior chimney as submitted. The motion failed. Therefore, the applicants' request will be automatically approved if the Board does not take action prior to the next hearing.

REASON: Those Board members in support believed the chimney was appropriate and would clearly read as an addition. They noted that exterior chimneys had been approved before. Those in opposition felt the new exterior chimney was not appropriate and agreed with the Staff analysis.

SPEAKERS: Karen & Bill Conkey, homeowners, spoke in support. The Conkeys suggested that the requested alteration was relatively minor, referred to other exterior chimneys added to houses in the neighborhood and noted that an existing tree partially blocks views to the chimney.

BOARD ACTION, January 26, 2005: Approved as amended, 4-2 (New Garage).

On a motion by Mr. Lloyd, seconded by Mr. Zuckerkandel, the Board approved the garage with the following conditions:

1. That the applicant record a zoning restriction form with the deed indicating the proposed office on the second floor of the garage will be used only as an office and not as a separate dwelling; and,
2. That the statements below must appear in the General Notes of the site plan so that on-

site contractors are aware of the requirements:

Contact Alexandria Archaeology (703-838-4399) two weeks prior to any ground disturbing activity (such as coring, grading, filling, vegetation removal, undergrounding utilities, pile driving, landscaping and other excavations as defined in Section 2-151 of The Zoning Ordinance) on this property. City archaeologists will provide on-site inspections to record significant finds.

Call Alexandria Archaeology immediately (703-838-4399) if any buried structural remains (wall foundations, wells, privies, cisterns, etc.) or concentrations of artifacts are discovered during development. Work must cease in the area of the discovery until a City archaeologist comes to the site and records the finds.

The applicant should not allow any metal detection to be conducted on the property, unless authorized by Alexandria Archaeology.

The vote on the motion was 4-2 (Mr. Meick and Ms. Kelley opposed).

REASON: The Board believed the proposed garage met the *Design Guidelines* and noted that the *Guidelines* allow for “new and untried approaches,” as long as they are compatible with the architecture in the district. The Board noted that the architectural character of the Parker-Gray District was more simple and vernacular than that of the Old and Historic District and what might be appropriate in one would not necessarily be appropriate in the other. Mr. Cromley described the garage as “a good piece of architecture,” noting that the design took cues of form and material from the neighborhood, and suggested that its location in an alley allowed for more experimentation in the design. Board members agreed that the existing alley is not very attractive. On the other hand, several Board members expressed concern that the zinc cladding proposed for the garage was too untraditional a material and the panels too large in scale for the garage. Ms. Kelley questioned how the zinc would withstand the humidity of the climate. Several members also questioned whether the height of the garage was appropriate for the setting. All Board members agreed that it was unfortunate that the applicants had not spoken with Mr. Deakins about their plans prior to applying to the Board. It was noted that good communication was essential in the densely developed historic districts and that the neighbor’s goodwill was a necessity when it came time to build. However, Mr. Cromley also made the point that the Board of Architectural Review is not empowered to consider the preservation of neighbor’s privacy, but only the appropriateness of the design as seen from the public right of way.

SPEAKERS: Karen and Bill Conkey, homeowners, spoke in support. They explained how the form was shaped by their need for space, a desire to preserve existing landscaping and the zoning requirements, but also reflected traditional forms within the district. The design is intended to appear as a 21st century addition to the neighborhood and to reflect the architecture of the alley. Originally they had proposed barn board cladding but were required by Code Enforcement to use

a noncombustible material. They selected the zinc panels as alley buildings were often clad in metal and they believed the zinc would weather well. The applicants stated that the design of the garage met the intent and spirit of the *Design Guidelines*. The applicants also explained that they had attempted to consult with their neighbors, including Mr. Deakins.

Raymond Deakins, owner of 327 North Patrick Street, spoke in opposition. He explained that he had owned the adjacent property for many years and had tried to be respectful of the 19th century character of his house as he restored it. He explained that he believed the proposed garage was out of context with the neighborhood in terms of its scale, design and material. He suggested that the appearance of the garage should relate to the 19th century. He explained that his privacy at the back of the house would be adversely affected by the new two story structure. Mr. Deakins provided photographs to illustrate his points and requested a deferral to allow an opportunity to discuss revisions to the project with the applicants.

Gaver Nichols, architect and resident at 319 East Monroe Street, spoke in opposition. He stated that he believed the scale and design was inappropriate and requested that the Board defer for restudy. Mr. Nichols noted the importance of working with neighbors in the design of a project.

Kevin Abbot, owner of 330 North Patrick Street, spoke in support. He agreed with the applicants that the alley location allows for a more free-form vocabulary.

***EXPIRATION OF APPROVALS NOTE:** In accordance with Sections 10-106(B) and 10-206(B) of the Zoning Ordinance, any official Board of Architectural Review approval will expire 12 months from the date of issuance if the work is not commenced and diligently and substantially pursued by the end of that 12-month period.

****BUILDING PERMIT NOTE:** Most projects approved by the Board of Architectural Review require the issuance of one or more construction permits by the Code Enforcement Bureau (including signs). The applicant is responsible for obtaining all necessary construction permits after receiving Board of Architectural Review approval. Contact Code Enforcement, Room 4200, City Hall, 703-838-4360 for further information.

STAFF RECOMMENDATION:

Staff recommends approval of the application with the following conditions:

1. That the chimney be an interior brick chimney;
2. That the applicant record a zoning restriction form with the deed indicating the proposed office on the second floor of the garage will be used only as an office and not as a separate dwelling;
3. That the garage be clad in vertical board-and-batten fiber cement siding;
4. That the fiber cement be smooth finish and painted;
5. That the fence be painted or stained; and,
6. That the statements below must appear in the General Notes of the site plan so that on-site contractors are aware of the requirements:

Contact Alexandria Archaeology (703-838-4399) two weeks prior to any ground disturbing activity (such as coring, grading, filling, vegetation removal, undergrounding utilities, pile driving, landscaping and other excavations as defined in Section 2-151 of The Zoning Ordinance) on this property. City archaeologists will provide on-site inspections to record significant finds.

Call Alexandria Archaeology immediately (703-838-4399) if any buried structural remains (wall foundations, wells, privies, cisterns, etc.) or concentrations of artifacts are discovered during development. Work must cease in the area of the discovery until a City archaeologist comes to the site and records the finds.

The applicant should not allow any metal detection to be conducted on the property, unless authorized by Alexandria Archaeology.

NOTE: Docket item #4 must be approved before this docket item is considered.

I. ISSUE:

The applicant is requesting approval of a certificate of appropriateness for the installation of an exterior masonry chimney at the center of the south wall of the main block of the frame house and for the construction of a new two story garage/office at the rear of the property. The property is visible from both Patrick Street and from the alley at the rear. The rear of the property is also somewhat visible from Princess Street looking down the alley.

Chimney

The off-set red brick chimney will project 1'8" from the south wall and will be 4'8" wide from the base to the top of the first story where it will begin to taper in to a width of approximately 2' wide and will continue at that width up the remainder of the second story. The chimney will project 3'1" above the roof at its highest point. The brick will be set in a running bond and will be Color #115 - Shenandoah by Cushwa Brick. A brick sample will be available for the Board's inspection at the meeting. According to the applicant, the mortar will match the brick.

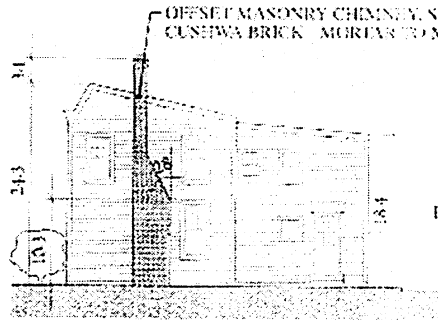

Figure 11 - Proposed chimney

Garage/Office

The garage will be located 1' back from the rear (east) property line on the north-south public alley. The garage will not extend the full width of the lot. It will be located on the north property line but will be 5' from the south property line. The two story frame garage will be composed of a nearly square (19'11" wide by 19'8" long) lower level for car parking and a smaller, rectangular (19'11" wide by 15' long) second level for home office use. The second level will be set back on the east (alley) elevation by 7'8" and will project on the west (yard) elevation by 3'. The offset second story creates a small pent roof above the first level on the alley elevation. Both this roof and the larger roof over the second story will slope from down from the house side to the alley side, but the lower roof will have a steeper pitch than the upper roof. On the east (alley) elevation, there will be a 16' wide garage door in the lower level. It will have multiple panels and a row of glazed lights at the top. There will be a series of three evenly spaced multi-light casement windows in the second level. The west (yard) elevation will have on the lower level a 16' wide garage door matching that on the alley side. As stated previously, the second level will project beyond the first on the yard side. The left hand side will be composed of a small cubicle-like extension with a multi-light casement window. To the right of this section will be an enclosed landing with a vertical slat wall and an open wood stairway from the landing to the yard. The stairway will have simple wood handrail with straight pickets. The north side elevation is on the property line and will have no openings. The south elevation is 5' from the property line and will have a pair of vertical slat wood doors in the first level and multi-light casement window with a vertical slat shutter in the second level.

The garage will be clad in a zinc wall system by VM Dexter. Originally, the applicant had proposed using 12" wide unfinished barn board siding. Due to the inaccessibility of the alley behind 325 North Patrick Street to fire equipment, Code Enforcement required that the new structure be sided in a non-combustible material. The siding currently proposed consists of 15 3/4" wide by 32" long panels made of zinc with a matte charcoal gray finish. The panels will be installed vertically with staggered seams. The roof will be clad in charcoal gray asphalt shingles. The downspouts and gutters will be zinc. The

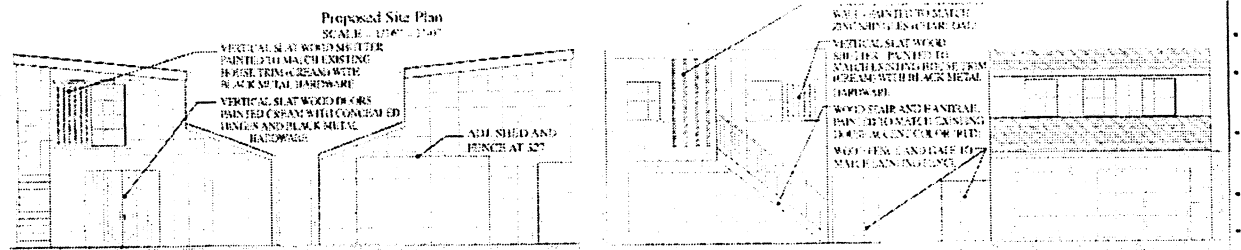

Figure 12 - Proposed new garage/office

garage doors will be cedar finish. The windows will be wood simulated divided light windows painted cream to match the trim on the house. Other wood elements will be painted cream or red, matching the trim and accent color of the house or charcoal to match the zinc siding.

The 5' wide area between the garage and property to the south will be enclosed with a 5'1/2" high flat board wood fence with gate.

II. HISTORY:

The two story, three bay, frame house with half mansard roof is a good example of highly popular Alexandria house type constructed for several decades beginning in the late 19th Century and continuing through the early 20th Century. The house at 325 North Patrick may date as early as the 1870s. Staff could not locate any prior BAR cases for this property.

In 1999, the Board approved the addition of a chimney at 329 North Patrick Street (BAR Case #99-00204, 11/10/1999). The applicant had requested approval of an exterior metal pipe chimney but Staff and Board believed this to be inappropriate for the house and instead approved an interior pipe chimney that was to be located on the back side of the gable roof. More recently, the Board approved the addition of a chimney at 330 North Patrick Street (BAR Case #2003-00182, 8/27/2003). In this case the applicant requested an interior metal pipe chimney. The interior chimney was approved with the condition that it be "built out and stuccoed." Staff could not locate any approvals for the exterior chimney at 321 Patrick Street, which is cited as an example in the materials submitted by the applicant.

The most recent garage approved by the Board was in 2001 in conjunction with the renovation and addition to the house at 408 North Patrick Street (BAR Case #2001-243, 12/19/2001). This garage, a simple, single story, flat roofed, brick clad structure was never built.

III. ANALYSIS:

The proposed alterations comply with zoning ordinance requirements. Section 3-706(A)(3)(b) of the zoning ordinance states any lot which is at least 25 feet but less than 35 feet wide shall provide one side yard of 5'. Section 3-706(A)(4) of the zoning ordinance states each residential use shall provide a rear yard of 8'. Wherever a lot abuts a rear alley, half of the alley width may be applied to the required rear setback. A certificate of occupancy for the garage is limited to a home based office use only. The applicant must record a zoning restriction form with the deed indicating the proposed office on the second floor of the garage will be used only as an office and

not as a separate dwelling.

Staff is unable to recommend approval of the chimney addition as proposed. The *Design Guidelines* state that new chimneys must be appropriate to the period of the structure (Chimneys - Page 2). The Guidelines also note that the vast majority of structures in the district have interior chimneys and flues and that “[e]xterior chimneys, that is, brick or masonry chimneys on the outside of a building wall, are found primarily on buildings dating from the late 18th and early 19th—centuries” (Chimneys - Page 1). Not only is the proposed chimney exterior, but it has the appearance of a fireplace chimney. A house of this period would most likely have been heated with stoves which tended to have narrow straight chimneys. Therefore, Staff recommends that the brick chimney be internal.

Staff recommends approval of the garage with some reservations. The *Design Guidelines* state that “accessory structures should complement, not compete with, the architecture of the main building” (Accessory Structures - Page 2). In the opinion of Staff, the unusual design of the garage, with its cantilevered form, modern detailing and use of a zinc wall system, can not be said to complement the late 19th century, clapboard clad house and could even be said to compete with the house if the two structures were visible side-by-side. However, Staff believes that the proposed design is generally acceptable in that the contrast between the new garage and historic house is most evident from within the property and will not be readily discernable from the public right-of-way. The garage should be barely, if at all visible from Patrick Street. While it will be visible from the public alley behind the property and from oblique views down the alley from Princess Street, that portion of the garage that will be visible is more conventional than the yard side.

However, Staff feels the use of the zinc wall system is inappropriate and accentuates the modern and unusual appearance of the new building to an unnecessary degree. The applicant has argued that this treatment is historically appropriate as many of the district’s older sheds and garages that remain are clad in metal. The use of corrugated or flat sheets of metal cladding to cover these simple frame structures appears to have been popular from circa 1920 through circa 1940. It often was used as a replacement cladding after the original wood siding had failed. The material is not characteristic of the late 19th century period of the house at 325 North Patrick Street and its neighbors. The appearance is industrial rather than residential in character. As an alternative, Staff recommends using painted, fiber cement planks with a smooth finish installed as vertical board-and-batten siding. Wood board-and-batten siding was commonly used for outbuildings in the latter part of the 19th century. Fiber cement is non-combustible and when painted has much the same appearance as painted wood. The Board has adopted the policy of allowing its use on non-historic structures providing that the siding is smooth (not wood grained) and that the nails do not show in the installation. According to the Hardi plank web site, fiber cement planks may be installed in a board-and-batten pattern. Staff believes this siding would help tie the new structure to the historic house in its visual character while still maintaining the clean vertical lines that the applicant desires.

The proposed fence replacement is appropriate. Staff notes that the *Design Guidelines* state that wood fences must be painted or stained.

Lastly, Staff notes the comments of Alexandria Archaeology and recommends that they be included as a condition to the approval.

IV. STAFF RECOMMENDATION:

Therefore, Staff recommends approval of the application with the following conditions:

1. That the chimney be an interior brick chimney;
2. That the applicant record a zoning restriction form with the deed indicating the proposed office on the second floor of the garage will be used only as an office and not as a separate dwelling;
3. That the garage be clad in vertical board-and-batten fiber cement siding;
4. That the fiber cement be smooth finish and painted;
5. That the fence be painted or stained; and,
6. That the statements below must appear in the General Notes of the site plan so that on-site contractors are aware of the requirements:

Contact Alexandria Archaeology (703-838-4399) two weeks prior to any ground disturbing activity (such as coring, grading, filling, vegetation removal, undergrounding utilities, pile driving, landscaping and other excavations as defined in Section 2-151 of The Zoning Ordinance) on this property. City archaeologists will provide on-site inspections to record significant finds.

Call Alexandria Archaeology immediately (703-838-4399) if any buried structural remains (wall foundations, wells, privies, cisterns, etc.) or concentrations of artifacts are discovered during development. Work must cease in the area of the discovery until a City archaeologist comes to the site and records the finds.

The applicant should not allow any metal detection to be conducted on the property, unless authorized by Alexandria Archaeology.

CITY DEPARTMENT COMMENTS

Legend: C - code requirement R - recommendation S - suggestion F - finding

Code Enforcement:

- F-1 The entrance to either side of the rear alley is 9 feet in width. The majority of the alley contains obstructions (fencing, structures, etc) on either side of the alley make the alley unable to support both fire apparatus, firefighters and equipment. In order to meet the requirements for fire access the following conditions are listed below:
- Pedestrian access from the front of the property facing Patrick Street through the side yard shall be maintained at all times to the proposed rear structure.
 - The exterior covering shall be comprised of non-combustible material subject to the approval of the Director of Code Enforcement.
- C-1 All exterior walls within 5 feet from an interior property line shall have a fire resistance rating of 1 hour, from both sides, with no openings permitted within the wall. As alternative, a 2 hour fire wall may be provided. This condition is also applicable to skylights within setback distance.
- C-2 Prior to the issuance of a demolition permit or land disturbance permit, a rodent abatement plan shall be submitted to Code Enforcement that will outline the steps that will taken to prevent the spread of rodents from the construction site to the surrounding community and sewers.
- C-3 Roof drainage systems must be installed so as neither to impact upon, nor cause erosion/damage to adjacent property.
- C-4 A soils report must be submitted with the building permit application.
- C-5 New construction must comply with the current edition of the Uniform Statewide Building Code (USBC).
- C-6 Alterations to the existing structure must comply with the current edition of the Uniform Statewide Building Code (USBC).
- C-7 Construction permits are required for this project. Plans shall accompany the permit application that fully detail the construction as well as layouts and schematics of the mechanical, electrical, and plumbing systems.
- C-8 Permission from adjacent property owners is required if access to the adjacent properties is required to complete the proposed construction. Otherwise, a plan shall be submitted to demonstrate the construction techniques utilized to keep construction solely on the referenced property.

- C-9 A wall location plat prepared by a land surveyor is required to be submitted to this office prior to requesting any framing inspection.

Historic Alexandria

"No comment."

Alexandria Archaeology

- F-1 During the Civil War, the Union Army constructed barns, stables, and sheds for ambulances on the 300 block of N. Patrick Street. After the war, residences were constructed along this street face, and the G.M. Hopkins Insurance Atlas for the City depicts a house present on this property by 1877. The area was part of the African American neighborhood, known as Uptown. The property therefore has the potential to yield archaeological resources that could provide insight into military activities during the Civil War as well as domestic life, perhaps relating to African Americans, in the later 19th century.
- R-1 Contact Alexandria Archaeology (703-838-4399) two weeks prior to any ground disturbing activity (such as coring, grading, filling, vegetation removal, undergrounding utilities, pile driving, landscaping and other excavations as defined in Section 2-151 of The Zoning Ordinance) on this property. City archaeologists will provide on-site inspections to record significant finds.
- R-2 Call Alexandria Archaeology immediately (703-838-4399) if any buried structural remains (wall foundations, wells, privies, cisterns, etc.) or concentrations of artifacts are discovered during development. Work must cease in the area of the discovery until a City archaeologist comes to the site and records the finds.
- R-3 The applicant should not allow any metal detection to be conducted on the property, unless authorized by Alexandria Archaeology.
- R-4 The above statements must appear in the General Notes of the site plan so that on-site contractors are aware of the requirements.

10-205 Matters to be considered in approving certificates and permits.

(A) Certificate of appropriateness

(1) **Scope of review.** The Parker-Gray District board of architectural review or the city council on appeal shall limit its review to exterior features subject to public view and shall determine the compatibility of proposed construction, reconstruction, alteration or restoration of buildings or structures within the Parker-Gray District based on compatibility with other buildings or structures on the same block face, the block face across the public street, or the immediate surrounding area within the district.

(2) **Standards.** The board of architectural review, or the city council on appeal, shall consider the following in passing upon the appropriateness of the proposals within the Parker Gray District:

(a) For new buildings and additions to existing buildings:

- (1) Height of the roofline along the street or public way;
- (2) Scale and mass of the building on the site;
- (3) Placement of the building on the site;
- (4) Material, texture and color;
- (5) Architectural style where there is a predominant style on the block face; and
- (6) Architectural details, including signs, subject to public view from the public street or public way.

(b) For modifications to existing buildings:

- (1) The degree to which the distinguishing original qualities or character of a building, structure or site including historic materials are retained;
- (2) The historic appropriateness of any new features; and
- (3) The compatibility of proposed alterations with other buildings on the block face or block face across the street, giving consideration to building size, shape, roofline, color, materials, texture, nature of openings, and architectural details.

- (c) The extent to which the buildings or structures in sections 10-205(A)(2)(a) and (b) above will promote the general welfare of the city and all citizens by the preservation and protection of the neighborhood.



RECORD OF APPEAL
FROM A DECISION OF THE BOARD OF ARCHITECTURAL REVIEW

Date Appeal Filed With City Clerk: 2/9/05
B.A.R. Case # 2004-0274
Address of Project: 325 N. PATRICK ST.
Appellant is: (Check One)

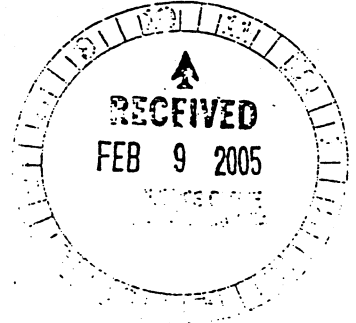

- B.A.R. Applicant
- Other Party. State Relationship * 327 N. PATRICK
ADJOINING PROPERTY OWNER
(* MOST AFFECTED)

MAILING

Address of Appellant: RAYMOND P. DEARINS
2409 S. INGE ST. ARLINGTON, VA. 22202
Telephone Number: 703-684-7391

State Basis of Appeal: ENCROACHES ON OUR LIGHT AND AIR.
THE STYLE, MATERIALS AND "MASSING" OF
THE BUILDING IS COMPLETELY INCOMPATIBLE
WITHIN THIS 19th. CENTURY NEIGHBORHOOD, THAT
WE'VE BEEN PART OF FOR 25 YEARS.

Attach additional sheets, if necessary.

A Board of Architectural Review decision may be appealed to City Council either by the B.A.R. applicant or by 25 or more owners of real estate within the effected district who oppose the decision of the Board of Architectural Review. Sample petition on rear.

All appeals must be filed with the City Clerk on or before 14 days after the decision of the B.A.R.

All appeals require a \$150.00 filing fee.



If an appeal is filed, the decision of the Board of Architectural Review is stayed pending the City Council decision on the matter. The decision of City Council is final subject to the provisions of Sections 10-107, 10-207 or 10-309 of the Zoning Ordinance.

Raymond P. Dearins
Signature of the Appellant

We, the undersigned owners of real estate within the ~~Old and Historic Alexandria District~~ Parker-Gray District [strike out as appropriate] appeal the decision of the Board of Architectural Review to the Alexandria City Council in B.A.R. Case #2004-0279 regarding the property at 325 N. PATRICK ST. (street address).

- | | Name | Signature | Owner of Real Property At: |
|-----|--|----------------------|----------------------------|
| 1. | DAVID L. McGreevy | David L. McGreevy | 426 N. Patrick St |
| 2. | Dorothy E. Taylor | Dorothy E. Taylor | 406 N. Alfred St. |
| 3. | Melissa A. Reed | Melissa A. Reed | 410 N. Alfred St. |
| 4. | Barbara Sumner | Barbara Sumner | 417 N. Alfred St. |
| 5. | Damian Kunko | Damian Kunko | 911 Princess St. |
| 6. | Carol Edwards | Carol Edwards | 909 Princess St. |
| 7. | Dorothy E. Harris | Dorothy E. Harris | 909 Princess St. |
| 8. | ROBERT C. LANDIS | [Signature] | 433 N. Patrick St |
| 9. | JOHN TURNER | [Signature] | 429 N. Patrick |
| 10. | Marie Randall | Marie Randall | 421 N. Patrick |
| 11. | Robert Gray | Robert Gray | 419 N. Patrick St. |
| 12. | William Chavitt | William Chavitt | 415 N. Patrick |
| 13. | Margaret A. Chesley | Margaret A. Chesley | 417 N. Patrick St. |
| 14. | N. Dawn Teague | N. Dawn Teague | 905 Princess St. |
| 15. | TAYLOR A. RICHARDSON | Taylor A. Richardson | 319 N. Alfred St. Alex VA |
| 16. | Charlotte Landis | Charlotte Landis | 433 N. Patrick St. |
| 17. | Dorothy A. Campbell | Dorothy A. Campbell | 313 N. Alfred St. |
| 18. | Dorothy A. Campbell | Dorothy A. Campbell | 425 N. Alfred St. |
| 19. | Juan A. McCreedy | Juan A. McCreedy | 426 N. Patrick St. Alex |
| 20. | Howard Dishman | Howard Dishman | 315 N. Patrick |
| 21. | Jane Dishman | Jane Dishman | 315 N. Patrick |
| 22. | MATT DUEEN | Matt Dueen | 918 QUEEN ST. |
| 23. | VIRGINIA DAILEY | VIRGINIA DAILEY | 220 N. PATRICK |
| 24. | Louise Elliott | Louise Elliott | 315 N. PATRICK ST |
| 25. | PEL TRADING GROUP, LLC
PAUL S. DUTTON | Paul Dutton | 1006 PENNINGTON ST. |
| 26. | Jesse Tarzan Branch | Jesse Tarzan Branch | 422 N. Henry |
| | | | 33 T. N. ... 1119 N. ... |

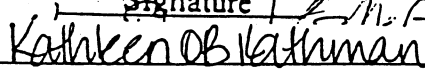
We, the undersigned owners of real estate within the ~~Old and Historic Alexandria District~~ Parker-Gray District (strike out as appropriate) appeal the decision of the Board of Architectural Review to the Alexandria City Council in B.A.R. Case # _____ regarding the property at 325 N. PATRICK ST. (street address).

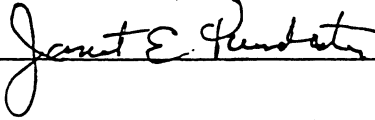
Name	Signature	Owner of Real Property At:
Kathleen O'Kathman		321 N. Fayette Street
Robert Allen		416 PRINCESS ST.
JANET Poindexter		314 N. FAYETTE ST

27
5-10-05

April 18, 2005

City of Alexandria
Room 2300, City Hall
Alexandria, Va. 22314
attn: Mayor William D. Euille

re: BAR Case #2004-0274 @ 325 W. Patrick St.

ms. Henderson
Near ~~ms. Mayo~~:

Enclosed is a copy of a letter
sent today (4/18/05) to Mr. and Mrs.
Conkey.

Thank you for your patience at
the public hearing on 4/16/05.

Sincerely,
Raymond P. Alestine

u

April 17, 2005

Bill and Karen Conkey,
325 N. Patrick St.
Alexandria, Va. 22314

Re: BAR case # 2004-0274 @ 325 N. Patrick St.

Dear Mr. and Mrs. Conkey:

The Mayor and City Council have asked us to address our differences in the spirit of compromise.

We both know that this is not an issue about how your proposed project relates to the alley. It is 100% about how it relates to the interior of our backyards.

The offer that I extended to you at the BAR hearing still stands: a two hour design consult, at my expense, with Mr. Gaver Nichols, a respected registered Architect in Alexandria.

Allow me to challenge you to eliminate the MASS and TEXTURE of this building. As you observed, the Mayor and majority of City Council also have major concerns with the size of this proposed building.

Part of this challenge is to step out of your insistence that "a building should look like the year it was built." Be respectful of your neighbors who live in the comfort of a 19th. century neighborhood where the assessed value of property reflects the protection a "historic district" affords the homeowners.

Your supporters, including your consultant, Mr. Crowley, are completely removed from the visual scene and impact that we @ 327 N. Patrick face.

At the hearing, it was mentioned that "there were no children in the area". One of the reasons may have to do with the incessant and intolerable traffic on Patrick St. This condition existed when you and I bought our properties. This forces us to retreat to the rear yard and eventually raise our children in other environs, away from this hazard.

Back to your proposed project. Surely, with your vast amount of skills and technology, a model,

as suggested by Councilman MacDonold, showing the impact of this building's density, would have been a minimum courtesy.

A Staff prepared aerial photo, and your one dimensional set of drawings, doesn't come close to showing how the proposed building relates to its neighbors.

The best compromise would be a: 1 story, "Hardie Plank" sided, addition that incorporates your home office with garage protection for your car. I believe Councilwoman Woodson suggested this at the hearing. This concept I would wholeheartedly support!

Essentially, provide us, not the alley, with the best elevation.

Hopefully, we can resolve these contentious issues. I will make myself available to achieve this goal. Enclosed is a copy of my plat to assist you.

Sincerely,
Raymond P. Meekins

- cc: • Mayor and City Council
• Chairman Parker Gray DAK
• Hal Phipps, Division Chief, Planning and Zoning
• Eileen Egan, Director, Planning and Zoning
• Saver Nichols, Architect

APRIL 14, 2005

DEAR MAYOR EVILLE & HONORABLE MEMBERS OF THE ALEXANDRIA CITY COUNSEL.

- THIS LETTER IS WRITTEN ON BEHALF OF MR. RAYMOND DEAKINS, OWNER OF 327 N. PATRICK STREET AND A LOCAL BUILDER WITH A HISTORY OF OVER 30 YEARS OF WORK IN ALEXANDRIA.
- I CAN ATTEST TO HIS SENSITIVITY TO OUR BUILT ENVIRONMENT (HOMES AND BUILDINGS) AND HIS CONCERN FOR OTHERS INCLUDING NEIGHBORS & CLIENTS. I AM WRITING ON HIS BEHALF WITH THE HOPE YOU WILL AFFORD HIM THE SAME.
- LAST MONTH I ATTENDED A BAR MEETING IN THE PARKER GRAY HISTORIC DISTRICT IN ORDER TO SUPPORT MR. DEAKINS IN HIS REQUEST FOR DEFERRAL OF AN APPLICATION FOR A GARAGE/OFFICE TO BE CONSTRUCTED NEXT TO HIS PROPERTY.
- MR. DEAKINS REQUEST SEEMED REASONABLE SINCE THE APPLICANT AND HE HAD NOT DISCUSSED THE PROPOSED PROJECT.
- DURING THE HEARING THE DEFERRAL WAS NOT HONORED, WHICH SURPRISED ME. MANY TIMES I HAVE COME BEFORE BOARDS AND HONORED REQUESTS SUCH AS MR. DEAKINS SO NEIGHBORS CAN DISCUSS PROJECTS WHERE MANY ARE AFFECTED.
- THIS LETTER IS A RESPONSE TO ASK YOU TO CONSIDER SENDING THIS PROPOSAL BACK TO THE B.A.R. FOR FURTHER STUDY SO NEIGHBORS CAN SPEAK, AND A COMPROMISE CAN BE REACHED.
- IF THIS STRUCTURE WAS BEING BUILT NEXT TO MY HOME I MOST DEFINATELY WOULD NOT SUPPORT IT AS I HAVE CONCERNS REGARDING THE COMPATIBILITY OF THE DESIGN TO EXISTING NEIGHBOR STRUCTURES, ITS HEIGHT IN THE INTERIOR COURT YARDS, AND THE FACT THAT NEIGHBORS STILL HAVE A CONCERN INCLUDING MR DEAKINS.
- MY COMMENTS ARE RESPECTFULLY SUBMITTED.

GAVIN NICHOLS, ARCHITECT.

27

5-10-05

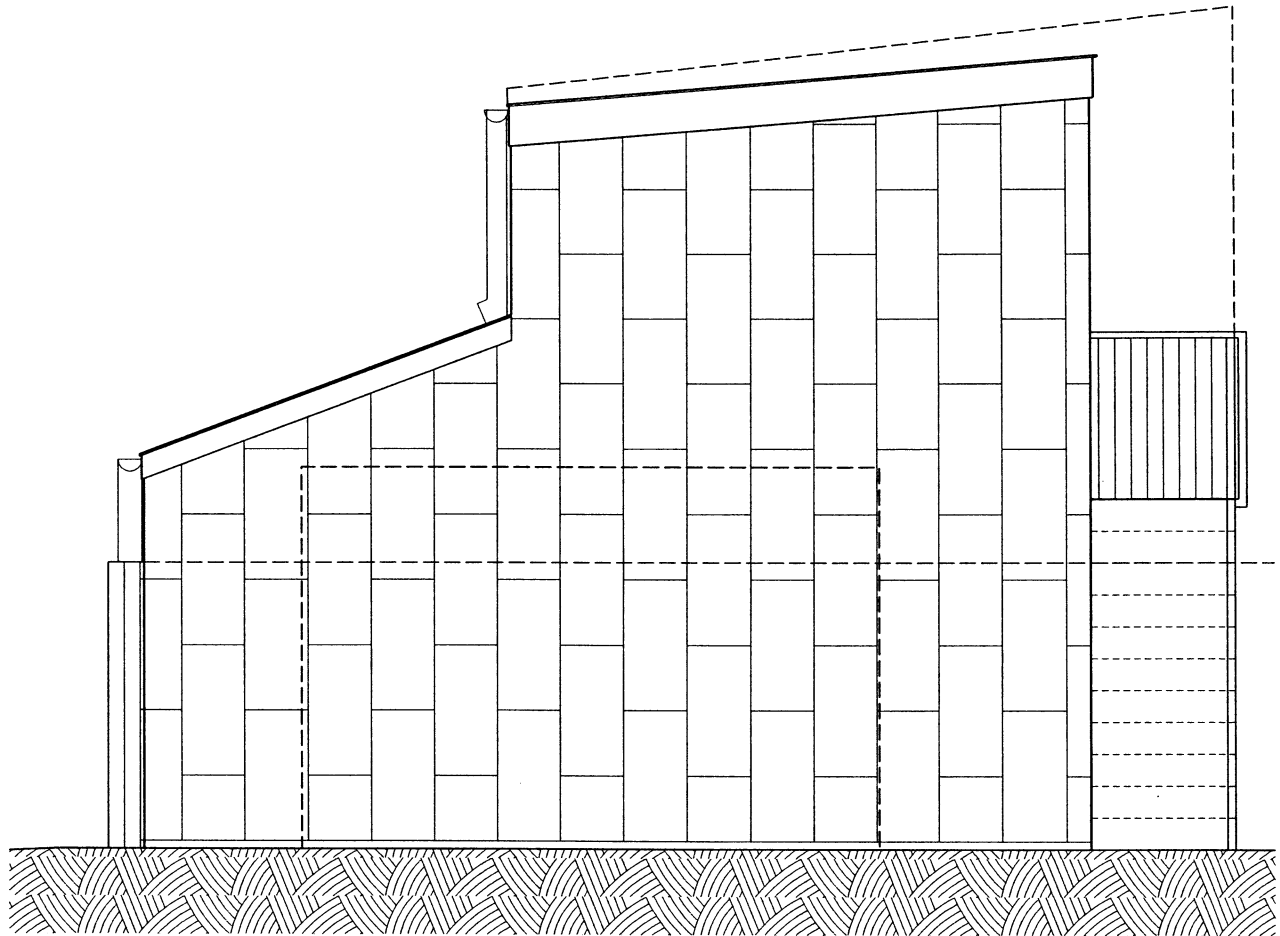

The Conkey Residence		
325 North Patrick Street Alexandria, VA 22314		
The Parker-Gray Board of Architectural Review		
Proposed Elevation Looking South		A005
SCALE 1/4" = 1'-0"	4-26-2005	



<p>The Conkey Residence 325 North Patrick Street Alexandria, VA 22314</p>		
<p>The Parker-Gray Board of Architectural Review</p>		
<p>Proposed Elevation Looking West</p>		<p>A006</p>
<p>SCALE 1/4" = 1'-0"</p>	<p>4-26-2005</p>	

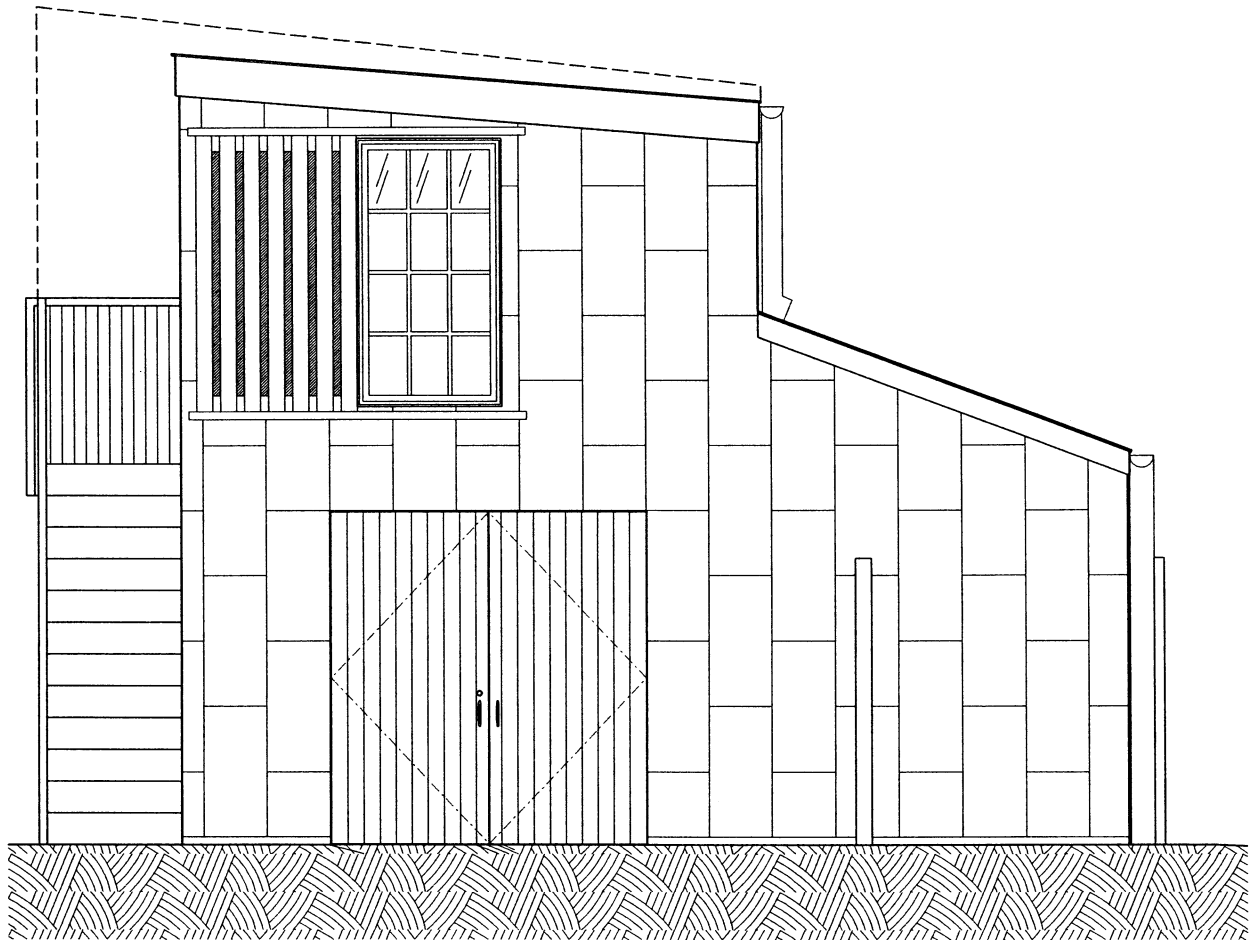

The Conkey Residence 325 North Patrick Street Alexandria, VA 22314		
The Parker-Gray Board of Architectural Review		
Proposed Elevation Looking North		A007
SCALE 1/4" = 1'-0"	4-26-2005	

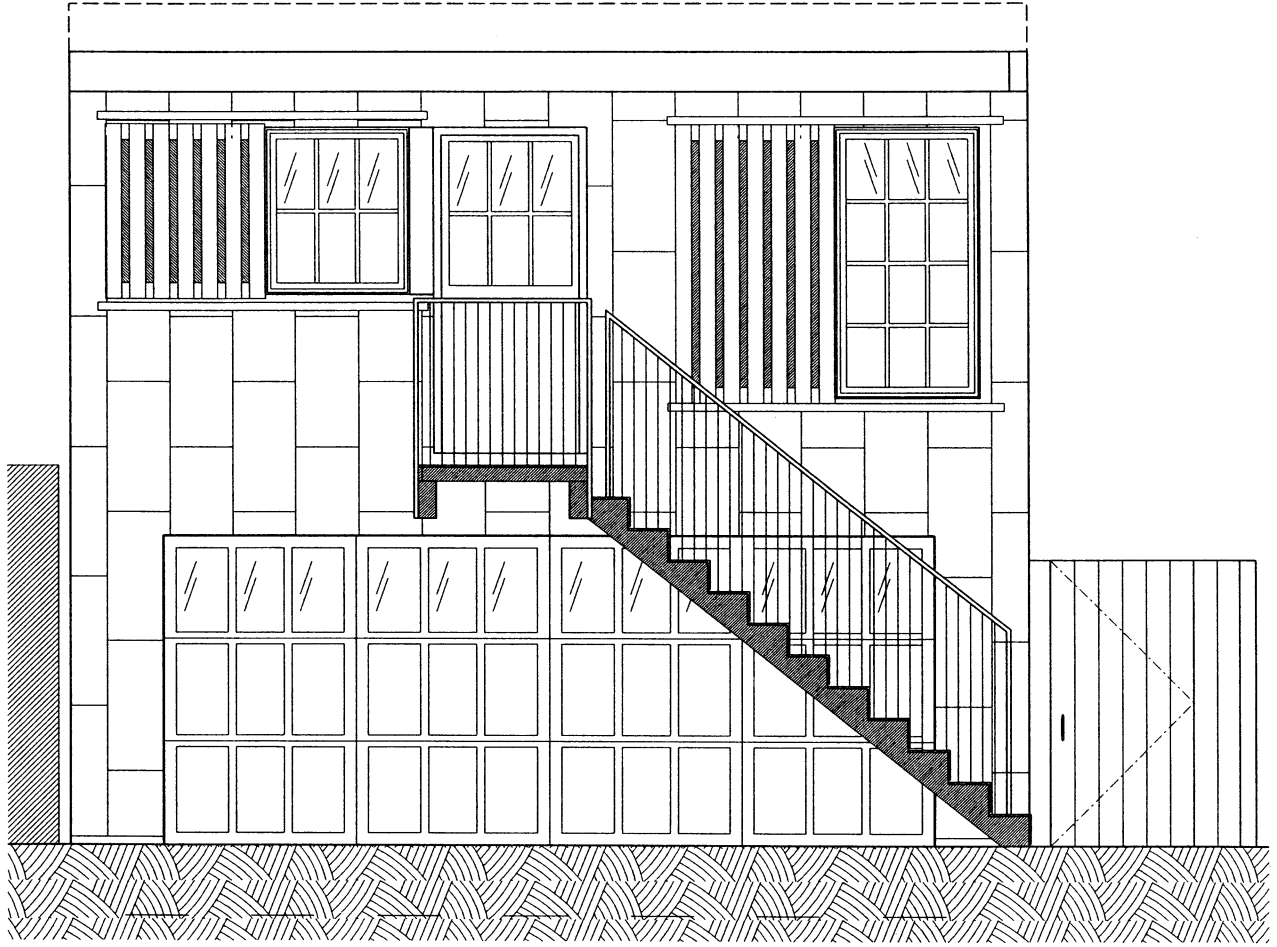

<p>The Conkey Residence 325 North Patrick Street Alexandria, VA 22314</p>		
<p>The Parker-Gray Board of Architectural Review</p>		
<p>Proposed Elevation Looking East</p>		<p>A008</p>
<p>SCALE 1/4" = 1'-0"</p>	<p>4-26-2005</p>	

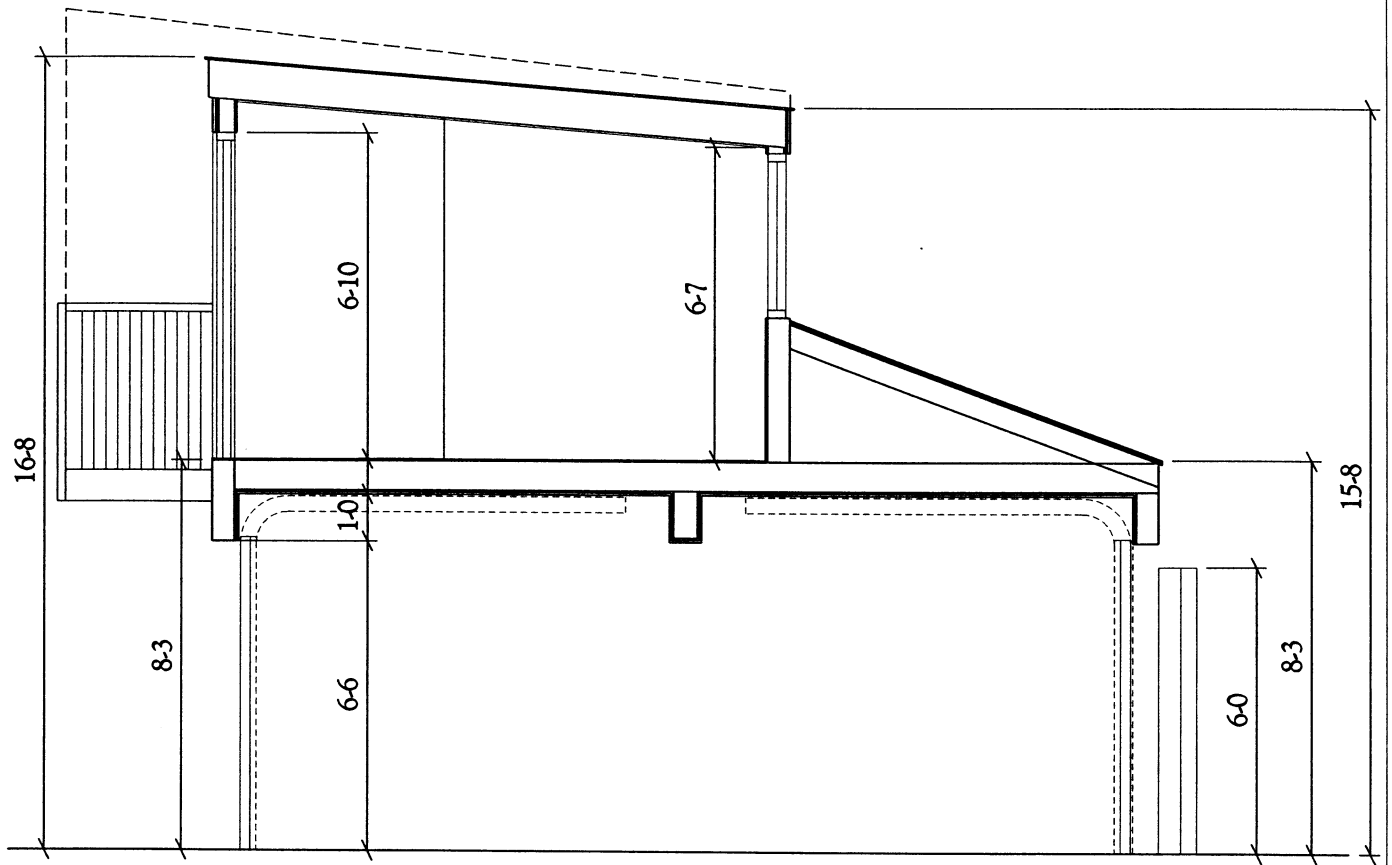

<p>The Conkey Residence 325 North Patrick Street Alexandria, VA 22314</p>		
<p>The Parker-Gray Board of Architectural Review</p>		
<p>Proposed Section</p>		<p>A009</p>
<p>SCALE 1/4" = 1'-0"</p>	<p>4-26-2005</p>	



Example of metal clad garage behind 426 North Fayette Street

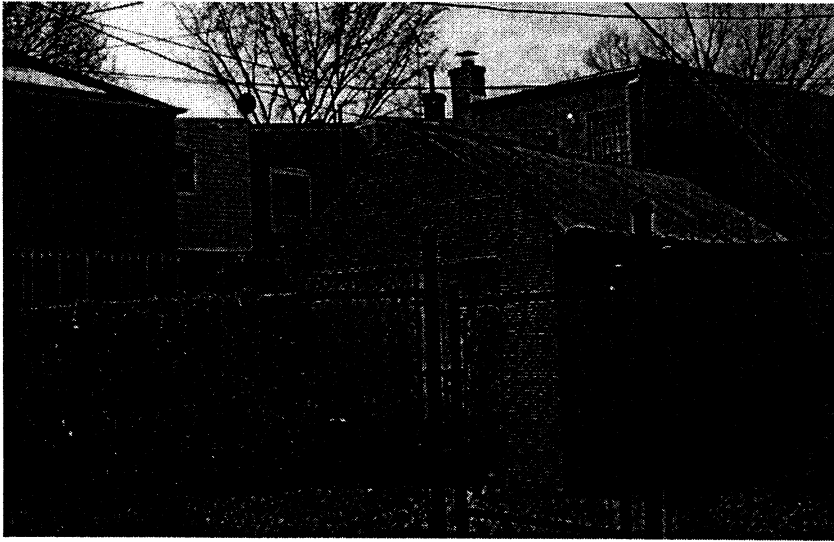

Example of metal clad garage behind 535 North Columbus Street



Example of metal clad garage in 100 block of North Peyton Street

27
5-10-05



<goldstein3@aol.com>

05/10/2005 12:21 PM

Please respond to
<goldstein3@aol.com>

To <alexvamayor@aol.com>, <delpepper@aol.com>,
<council@joycewoodson.net>, <councilmangaines@aol.com>,
<council@krupicka.com>, <macdonaldcouncil@msn.com>,

cc

bcc

Subject City of Alexandria Website Contact Us - EMail for Mayor,
Vice-Mayor and Council Members (alexvamayor@aol.com,
delpepper@aol.com, council@joycewoodson.net,
councilmangaines@aol.com, council@krupicka.com,
macdonaldcouncil@msn.com, paulcsmedberg@aol.com,
rose.boyd@alexandriava.gov, jackie.henderson@alexandriava.gov,
tom.raycroft@alexandriava.gov)

**City of Alexandria Website Contact Us - EMail for Mayor,
Vice-Mayor and Council Members (alexvamayor@aol.com,
delpepper@aol.com, council@joycewoodson.net,
councilmangaines@aol.com, council@krupicka.com,
macdonaldcouncil@msn.com, paulcsmedberg@aol.com,
rose.boyd@alexandriava.gov, jackie.henderson@alexandriava.gov,
tom.raycroft@alexandriava.gov)**

Time: [Tue May 10, 2005 12:21:55] IP Address: [205.188.117.14]

Response requested:

First Name: Sarah
Last Name: Goldstein
Street Address: 335 N. Patrick St.
City: Alexandria
State: VA
Zip: 22314
Phone: 703-683-6338
Email Address: goldstein3@aol.com
Council Members,

Comments:

I am writing as a resident of the Parker-Gray Historic District. The residents of 327 N. Patrick St. have plans to build a garage addition onto their home and the next-door neighbor (in 329) opposes this--he has gone so far as to erect a tall wooden beam in his yard with the spray-painted letters, "N-O-!" on it. I am writing as a resident and neighbor to voice my consent to the plans to build a garage addition to 327 N. Patrick and to voice my opposition to the wooden beam that the opposing neighbor has placed in his yard.

Thank you for your time,

Sarah Goldstein

27

5-10-05



Eileen Fogarty/Alex
05/10/2005 10:40 AM

To macdonaldcouncil@msn.com
alexvamayor@aol.com, delpepper@aol.com,
cc councilmangaines@aol.com, rob@krupicka.com,
paulcsmedberg@aol.com, council@joycewoodson.net,
bcc
Subject BAR Appeal - 325 North Patrick Street

- At the April 16, 2005 hearing, the Council asked that "the case be docketed for the next legislative meeting and that staff work with the applicant and consult with the appellant to identify ways to bring down the mass on the second floor." The appeal was deferred at the April 26, 2005 legislative meeting because applicant and appellant meetings and design revisions had not been completed. May 10, 2005 is the next legislative meeting of the Council.
- In response to the Council request, the applicant reduced the mass of the garage by reducing the height and depth. The appellant wanted more of the mass reduced and suggested eliminating the second floor office. The applicant was unwilling to do that.
- The appellant wanted a more traditional design for the garage. The applicant wanted to keep the original design. The staff recommends a more traditional siding (painted fiber cement) rather than the zinc siding proposed by the applicant.
- The staff recommends that the Council approve the revised design and that the garage be sided with painted fiber cement rather than zinc panels.

"Andrew Macdonald" <ahmacdonald@his.com>

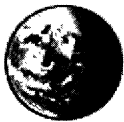

"Andrew Macdonald"
<ahmacdonald@his.com>
05/08/2005 01:17 PM

To "Eileen.Fogarty@Ci.Alexandria.Va.Us"
<eileen.fogarty@ci.alexandria.va.us>
<alexvamayor@aol.com>, <DElpepper@aol.com>,
<councilmangaines@aol.com>, <rob@krupicka.com>,
<paulcsmedberg@aol.com>, "Council@Joycewoodson.Net"
cc <council@joycewoodson.net>, <wmeuille@wdeuille.com>,
<Jim.Hartmann@alexandriava.gov>,
<Michele.Evans@alexandriava.gov>,
<Jackie.Henderson@alexandriava.gov>
Subject RE: BAR Appeal -325 North Patrick Street

Eileen,
Can you please tell me whether any of the appellant's concerns were addressed in this cooling off period; what Planning will recommend; and why if none of the appellant's -- Plannings -- basic concerns were resolved why we are obliged to hear this case again this Tuesday? (I can't recall if we set a time limit on these discussions.

Andrew Macdonald

[Andrew Macdonald] Can you -----Original Message-----

From: Andrew Macdonald [mailto:macdonaldcouncil@msn.com]

Sent: Saturday, May 07, 2005 5:44 PM

To: ahmacdonald@his.com

Subject: Fw: BAR Appeal -325 North Patrick Street

>From: <Eileen.Fogarty@alexandriava.gov>
>To: <alexvamayor@aol.com>, <delpepper@aol.com>,
<councilmangaines@aol.com>, <rob@krupicka.com>,
<macdonaldcouncil@msn.com>, <paulcsmedberg@aol.com>,
<council@joycewoodson.net>, <wmeuille@wdeuille.com>
>CC: <Jim.Hartmann@alexandriava.gov>, <Michele.Evans@alexandriava.gov>,
<Jackie.Henderson@alexandriava.gov>
>Subject: Fw: BAR Appeal -325 North Patrick Street
>Date: Fri, 6 May 2005 17:21:33 -0400
>
>The Honorable Mayor and Members of Council:
>
>You have received an email from Bill Conkey, the applicant for the garage
>at 325 North Patrick Street. I want to clarify a few points about the
>issues raised in the email concerning the staff recommendation for fiber
>cement siding rather than the zinc siding as proposed by Mr. Conkey.
>
>The recommendation for the fiber cement siding is consistent with the
>recommendation in the original report sent to the BAR and the
>recommendation that was made in the presentation before the Council on
>April 16, 2005. This more traditional siding would help the building
>better fit in with the 19th Century neighborhood given the non-traditional
>design of the structure. The request for the traditional siding was raised
>again by staff with Mr. Conkey after the Council hearing and before Mr.
>Conkey completed the redesign of the garage. Mr. Conkey said that he did
>not want to change the siding.
>
>In the redesign of the garage, many of the issues raised by the appellant,
>Mr. Deakins, including the design and texture of the garage, were not
>addressed. While the applicant reduced the second floor of the garage, Mr.
>Deakins did not feel that his request to significantly reduce the mass and
>make the garage more compatible with the 19th Century character of the

>neighborhood was achieved.

>

>Staff, in trying to balance the reasonable expectations of both the
>applicant and the appellant, continue to recommend the more traditional
>fiber cement siding. When painted, this siding gives the appearance of
>wood. The color of the siding is something that can be handled
>administratively by the staff in consultation with the applicant.

>

>

>

>

>

>

"William Conkey"

<BConkey@Esocoff

.com>

To

<alexvamayor@aol.com>,

05/06/2005 10:25 <delpepper@aol.com>,

AM <councilmangaines@aol.com>,

<macdonaldcouncil@msn.com>,

<paulcsmedberg@aol.com>,

<jackie.henderson@alexandriava.gov>,

<jim.hartmann@alexandriava.gov>

cc

"Karen Conkey" <KConkey@Esocoff.com>

Subject

BAR Appeal -325 North Patrik Street

>

>

>

>

>

>

>

>

>

>

>

>The staff report for the BAR Appeal of the property at 325 North Patrick

>Street was published yesterday. The report correctly describes the

>revisions that we made to the design to reduce the mass of the building as

>instructed by City Council. By reducing the headroom inside the structure

>to the minimum allowable by the building code and by flattening the roof

>slope, we were able to reduce the overall height of the building from

>17' to 16'-8". We also removed the cantilevered section at the west side

>of the garage that contained the bathroom and the second floor entry. When

>we met with the Planning and Zoning staff, we presented a number of

>different options to reduce the height and the mass and we all agreed that
>the reduced headroom and flattened roof slope option was the best of the
>many options that we presented. The removal of the cantilevered bump out
>on the west side of the building was something that was required by the
>Planning and Zoning staff, and was not one of the options that we
>presented. We have prepared a number of drawings, some of which have been
>included in the report, and we are making a model showing the adjoining
>properties for the meeting this Tuesday.

> The staff report also contains a recommendation regarding the
>replacement of the approved zinc siding with fiber cement painted to match
>the house. We were surprised to see this recommendation as a part of the
>report. This issue never came up in our meetings with the staff and was
>only brought up as an offhand comment during a phone call with a Planning
>and Zoning staff member. Because this was never a part of our discussions
>with the staff we were not able to make our case for why we think that the
>zinc is not only acceptable, but is the preferred material for the garage.
>The issue of the exterior cladding material was also not a part of the
>discussions at the City Council hearing, and was not mentioned in the very
>specific motion made by Council. The motion stated that the case be
>docketed for the next legislative meeting and that the staff work with the
>applicant and consult with the appellant to identify ways to bring down the
>mass on the second floor, nowhere in this motion was the exterior cladding
>material mentioned. The inclusion of this recommendation in the staff
>report is well outside of the spirit of the Council discussion and the
>Council's request, and the lack of discussion with us about this topic make
>this recommendation inappropriate and unfair. The recommendation also says
>that the siding is to be painted to match the house. This is a very broad
>comment which can be interpreted to include a number of different color
>options. This lack of specificity is reflective of the lack of discussion
>about this topic. We would ask that if Council decides to approve the
>staff's recommendation we would like a more specific discussion about the
>colors to avoid further disagreements over this garage.

> Please feel free to contact me by e-mail or phone with any
>questions or to arrange a site visit as suggested in my previous e-mails.

>
>

>Bill Conkey
>325 North Patrick Street
>H-703-519-3748
>C-703-628-1240

>